

The ME series of Gefran, are pressure transmitters for using in High temperature environment.

The main characteristic of this series is the capability to read temperature of the media up to 400°C.

The constructive principle is based on the hydraulic transmission of the pressure.

The fluid-filled system assures the temperature stability.

The physical measure is transformed in a electrical measure by means the strain-gauge technology.

MAIN FEATURES

- Pressure ranges from:
0-35 to 0-2000 bar / 0-500 to 0-30000 psi
- Accuracy: $\pm 0.25\%$ FSO (H); $\pm 0.5\%$ FSO (M)
- Fluid-filled system for temperature stability
- Mercury filling volume:
ME0 (30mm³); ME1, ME2, ME3 (40mm³)
- 1/2-20UNF, M18x1.5 standard threads; other types available on request
- Autozero function on board / external option
- Drift Autocompensation function (SP version)
- Standard diaphragm is 15-5 PH stainless steel with GTP coating
- 17-7 PH corrugated diaphragm with GTP coating for ranges below 100 bar-1500 psi

GTP (advanced protection)

Coating with high resistance against corrosion, abrasion and high temperature

AUTOZERO FUNCTION

All signal variations in the absence of pressure can be eliminated by using the Autozero function.

This function is activated by closing a magnetic contact located on the transmitter housing.

The procedure is permitted only with pressure at zero.

AUTOCOMPENSATES INFLUENCE OF MELT TEMPERATURE

Thanks to internal self-compensation, the MSP series transmitter cancels the effect of pressure signal variation caused by variation of Melt temperature.

This reduces at the minimum the read error caused by heating of the filling fluid (typical of all sensors built with "filled" technology).

TECHNICAL SPECIFICATIONS

Accuracy (1)	H $\pm 0.25\%$FSO (100...2000 bar) M $\pm 0.5\%$FSO (35...2000 bar)
Resolution	Infinite
Measurement range	0..35 to 0..2000bar 0..500 to 0..30000psi
Maximum overpressure (without degrading performances)	2 x FS 1.5 x FS above 1000bar/15000psi
Measurement principle	Extensimetric
Power supply	10...30Vdc
Maximum current absorption	32mA
Insulation resistance (at 50Vdc)	>1000 MOhm
Output signal Full Scale (FSO)	20mA
Zero balance (tolerance $\pm 0.25\%$ FSO)	4mA
Zero signals adjustment (tolerance $\pm 0.25\%$ FSO)	"Autozero" function
Span adjustment within $\pm 5\%$ FSO	See Manual
Maximum allowed load	See diagram
Response time (10...90% FSO)	~ 1ms
Output noise (RMS 10-400Hz)	<math>< 0.025\%</math> FSO
Calibration signal	80% FSO
Output short circuit ingress and reverse polarity protection	YES
Compensated temperature range	0...+85°C
Operating temperature range	-30...+105°C
Storage temperature range	-40...+125°C
Thermal drift in compensated range: Zero / Calibration / Sensibility	<math>< 0.02\%</math> FSO/°C
Diaphragm maximum temperature	400°C / 750°F
Zero drift due to change in process temperature (zero)	<math>< 0.02</math> bar/°C
Zero drift temperature for Autocompensated version (SP) within the temperature range 20°C-400°C inclusive the drift temperature of the housing	<math>< 0.003</math> bar/°C 100 \leq p <math>< 500</math> bar 0.0014 %FS/°C p \geq 500 bar
Standard material in contact with process medium	Diaphragm: • 15-5 PH with GTP coating • 17-7 PH corrugated diaphragm with GTP coating for ranges <math>< 100</math> bar (1500psi) Stem: • 17-4 PH
Thermocouple (model ME2)	STD: type "J" (isolated junction)
Protection degree (with 6-pole female connector)	IP65

FSO = Full scale output : (1) BFSL method (Best Fit Straight Line): includes combined effects of Non-Linearity, Hysteresis and Repeatability.

MECHANICAL DIMENSIONS

ME0

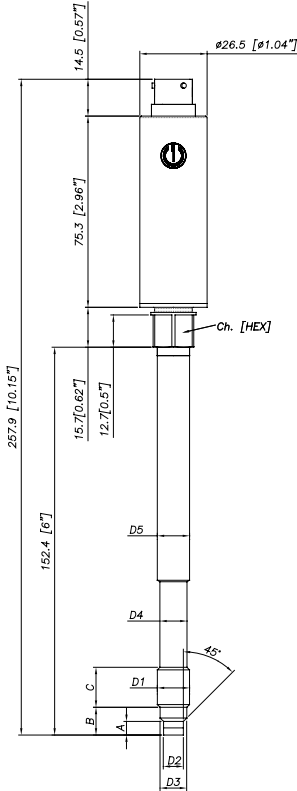

D1	1/2 - 20UNF
D2	ø7.8 -0.05 [ø0.31" -0.002]
D3	ø10.5 -0.025 [ø0.41" -0.001]
D4	ø10.67 [ø0.42"]
D5	ø12.7 [ø0.5"]
A	5.56 -0.26 [0.22" -0.01]
B	11.2 [0.44"]
C	15.74 [0.62"]
Ch	16
[Hex]	[5/8"]

ME2

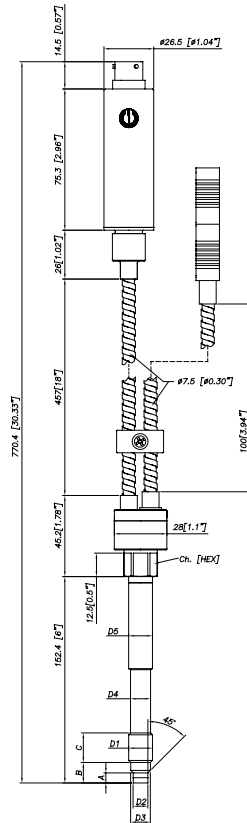

ME3

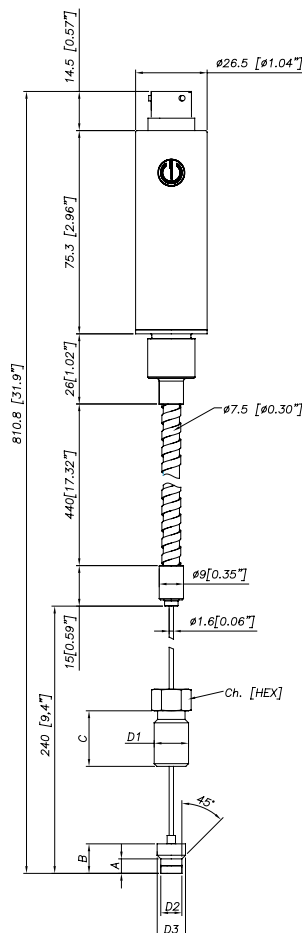

Exposed capillary	
D1	1/2-20UNF
D2	.307/.305" [7.80/7.75mm]
D3	.414/.412" [10.52/10.46mm]
A	.125/.120" [3.18/3.05mm]
B	.318/.312" [8.08/7.92mm]
C	.81" [20.6mm]

D1	M18x1.5
D2	ø10 -0.05 [ø0.394" -0.002]
D3	ø16 -0.08 [ø0.63" -0.003]
D4	ø16 -0.4 [ø0.63" -0.016]
D5	ø18 [ø0.71"]
A	6 -0.26 [0.24" -0.01]
B	14.8 -0.4 [0.58" -0.016]
C	19 [0.75"]
Ch	19
[Hex]	[3/4"]

NOTE : dimensions refer to rigid stem length option "4" (153 mm – 6")

WARNING : For installation use a maximum tightening torque of 56 Nm (500 in-lb)

ELECTRICAL CONNECTIONS

CURRENT OUTPUT (4...20mA, two wires)

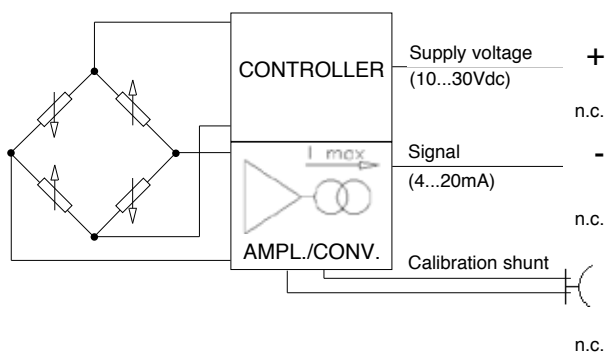

6 pin connector
VPT07RA10-6PT2
(PT02A-10-6P)

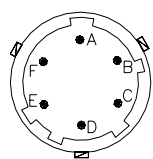

8 pin connector
PC02E-12-8P Bendix

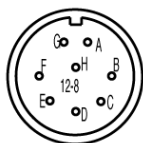

MAGNETIC AUTOZERO

6-pin	8-pin
A	B
C	A
B	D
D	C
E - F	E - F
	G - H

Shield drain wire is tied to connector via cable clamp

EXTERNAL AUTOZERO

6-pin	8-pin
A	B
C	A
B	D
D	C
E - F	E - F
	G - H

LOAD DIAGRAM

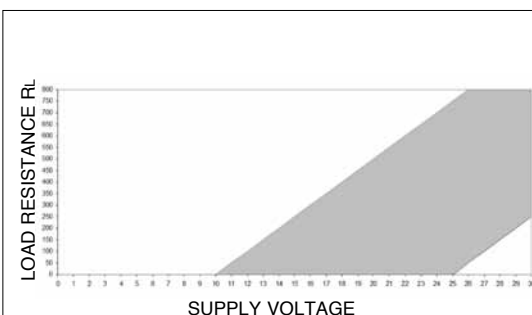

The diagram shows the optimum ratio between the load and supply voltage of the 4...20mA transmitter.

For a correct use, choose any combination of load resistance and supply voltage, in the shaded area.

AUTOZERO FUNCTION

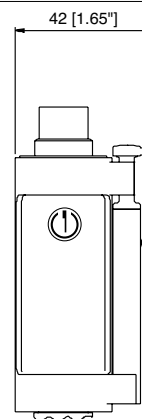

The Autozero function is activated through a magnetic contact (external magnet supplied with the sensor).

See the manual for a complete Autozero function explanation.

ACCESSORIES

Connectors

6-pin mating connector (IP65 protection degree)

8-pin mating connector

Extension cables

6-pin connector with 8m (25ft) cable

6-pin connector with 15m (50ft) cable

6-pin connector with 25m (75ft) cable

6-pin connector with 30m (100ft) cable

Other lengths

Accessories

Mounting bracket

Dummy plug for 1/2-20UNF

Dummy plug for M18x1.5

Drill kit for 1/2-20UNF

Drill kit for M18x1.5

Cleaning kit for 1/2-20UNF

Cleaning kit for M18x1.5

Fixing pen clip

Autozero pen

Thermocouple for ME2 model

Type "J" (153mm - 6" stem)

CON300

CON307

C08WLS

C15WLS

C25WLS

C30WLS

consult factory

SF18

SC12

SC18

KF12

KF18

CT12

CT18

PKIT309

PKIT312

TTER 601

Cable color code

Conn.	Wire
A	Red
B	Black
C	White
D	Green
E	Blue
F	Orange

